

Código de producto

BC1-1103-7114**Ficha técnica de la máquina**

Categoría: 3x16 A, 24 V (3 polos)

**Especificaciones técnicas**

AMPERIO	3/16A
POLAR	3P
TENSION	24 V
HERTZ	50 Hz - 60 Hz
CLASE IP	IP67
MATERIAL CONDUCTOR	58 d. C.
MATERIAL DEL CUERPO	Poliamida 6
GRAM	128
CANTIDAD POR CAJA	8
NÚMERO DE CAJAS	144

Certificados de calidad

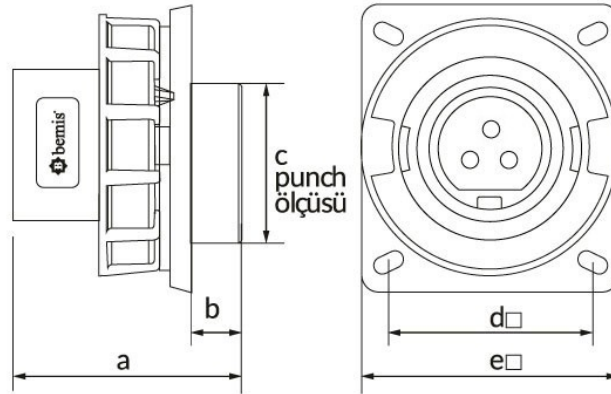
BC1-1103-7114**Dibujo técnico**

Ölçüler / Dimensions (mm)			
a	61,5	e	75
b	24	f	
c	40	g	
d	58	h	