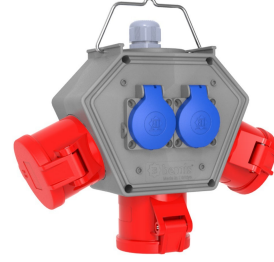

Product Code

BX1-0777-2100**Polybox**

Category: Polybox

**Technical Specifications**

IP RATING	IP44
CONDUCTIVE MATERIAL	A.D. 58
BODY MATERIAL	Polyamide 6
GRAM	155
BOX QUANTITY	1
NUMBER OF BOXES	6
PLUG OPTION	With a plug
CONNECTION TYPE	Related

Socket Configuration

	3 Adet Priz	2 Adet Priz
Amper	5/32A	1/16A
Volt	380V-450V	220V-250V
Kutup	3P+E+N	2P+E
Hertz	50Hz - 60Hz	50Hz - 60Hz

Quality Certificates

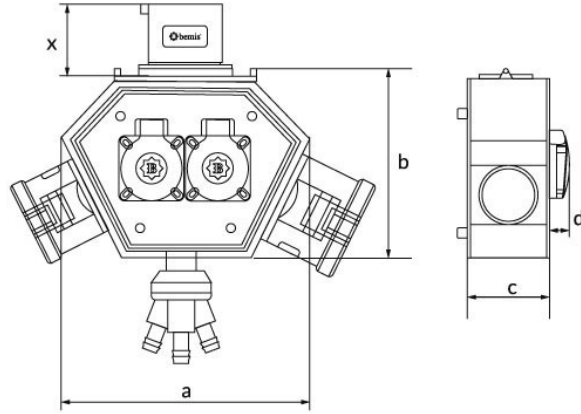
BX1-0777-2100**Technical Drawing**

Ölçüler / Dimensions (mm) x			
a	188	3/4/5 - 16A Priz / Socket	46
b	148	3/4/5 - 32A Priz / Socket	57
c	86	3/4/5 - 32A Fiş / Plug	46
d	18	3'lü Hava Çıkışı / Air Outlet	90