

## Product Code

**BCS-3504-7420****45° Angled Panel Mounted Socket**

Category: 4x32A (3P+E) 6h

**Technical Specifications**

AMPERE	4/32A
POLE	3P+E
TENSION	380V-450V
CLOCKWISE	6h
HERTZ	50 Hz - 60 Hz
IP RATING	IP67
CONDUCTIVE MATERIAL	A.D. 58
BODY MATERIAL	Polyamide 6
BOX QUANTITY	4
NUMBER OF BOXES	72

**Quality Certificates**

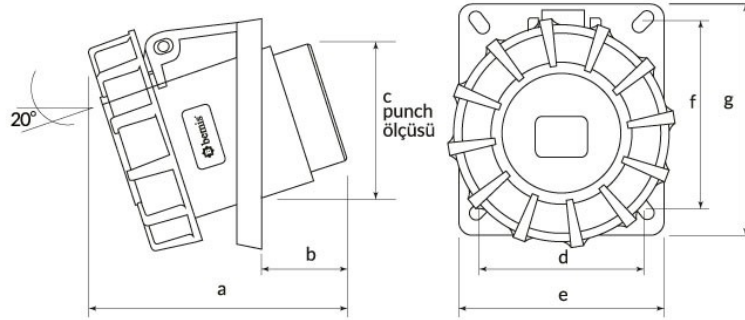
**BCS-3504-7420****Technical Drawing**

Ölçüler / Dimensions (mm)			
a	107	e	91
b	42	f	82
c	80	g	100
d	77	h	