

Product Code

BC1-3505-7537**90° Angled Surface Socket
with Schuko**

Category: 5x32A (3P+E+N) 6h

**Technical Specifications**

AMPERE	32A
POLE	3P+E+N
TENSION	380V-450V
CLOCKWISE	6h
HERTZ	50 Hz - 60 Hz
IP RATING	IP67
CONDUCTIVE MATERIAL	A.D. 58
BODY MATERIAL	Polyamide 6
GRAM	603,1
BOX QUANTITY	1
NUMBER OF BOXES	18

Quality Certificates

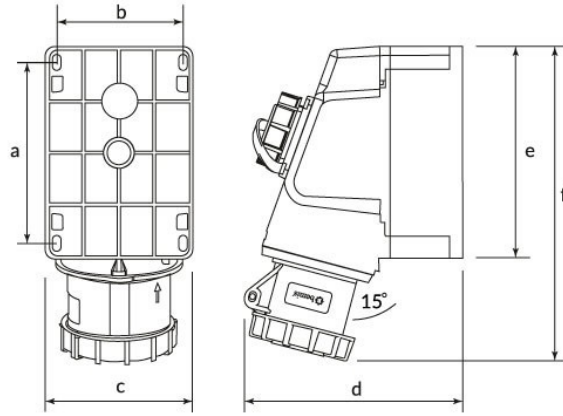
BC1-3505-7537**Technical Drawing**

Ölçüler / Dimensions (mm)			
a	113	e	131
b	82	f	208
c	91	g	
d	150	h	